

modelo QUADRADO  
modelo QUADRADO

292105

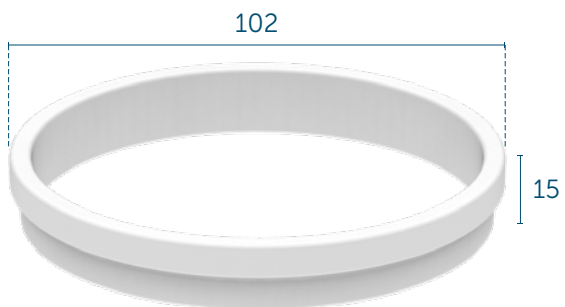
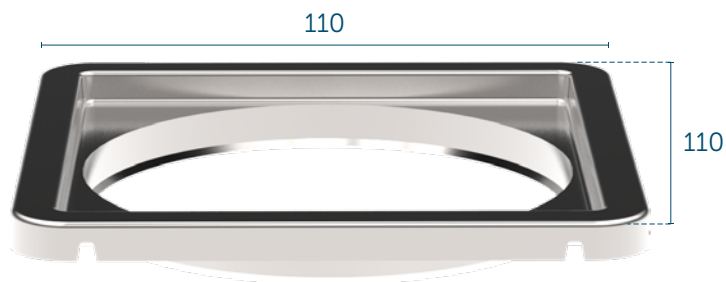

DIÂMETROS DO ANEL  
DIÁMETROS DEL ANILLO

102  
98

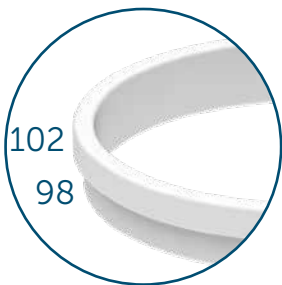

modelo QUADRADO  
modelo QUADRADO

292106

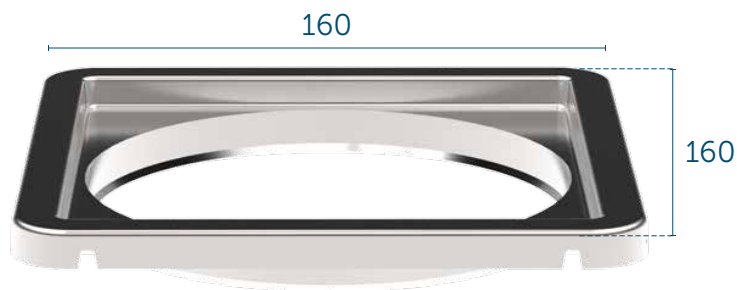

DIÂMETROS DO ANEL  
DIÁMETROS DEL ANILLO

150  
147  
143

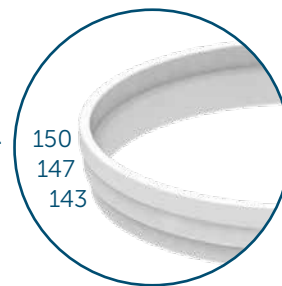

**DESCRIÇÃO CATÁLOGO:**

Porta Grelha Quadrada para Caixas Sifonadas e Ralos

| Referência | Material | Largura | Observação |
|------------|----------|---------|------------|
| 292105-61  | AISI 304 | 100mm   | -          |
| 292106-61  | AISI 304 | 150mm   | -          |



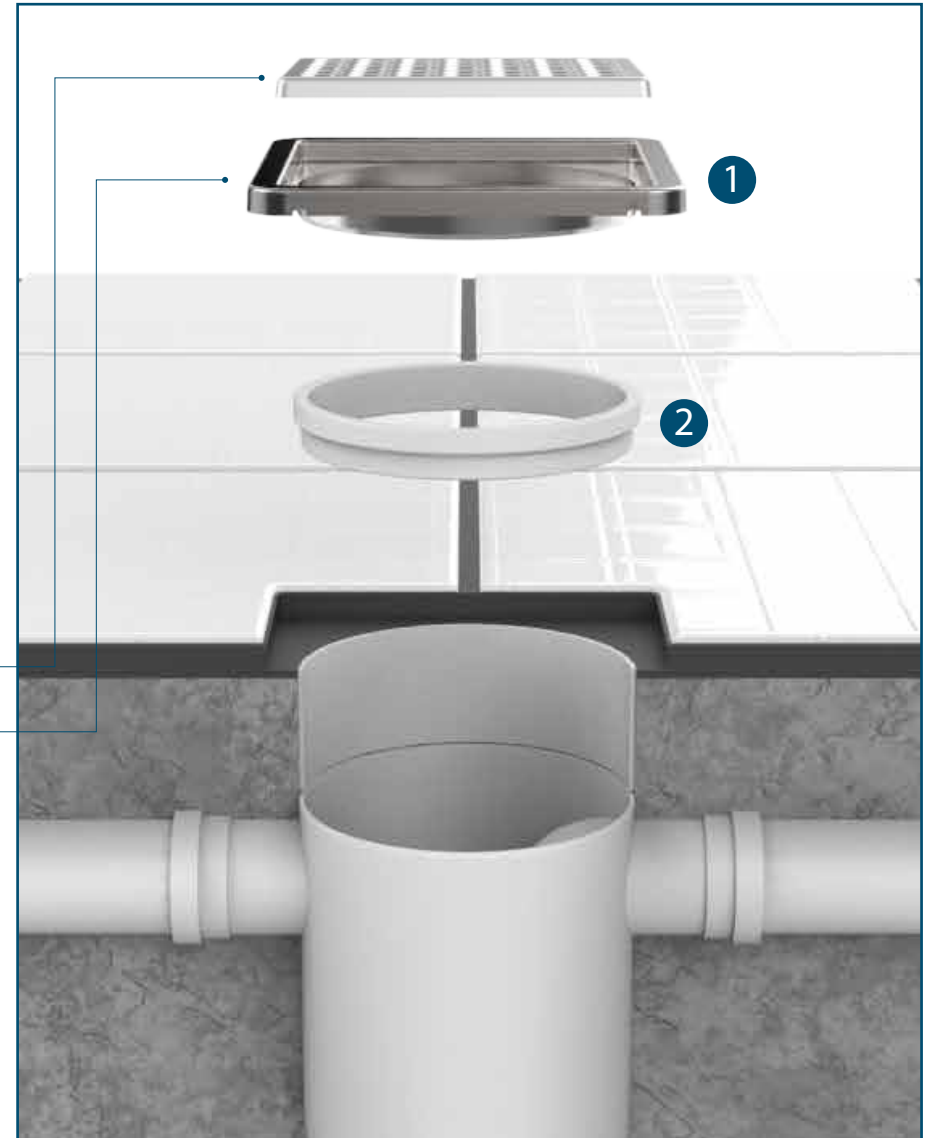
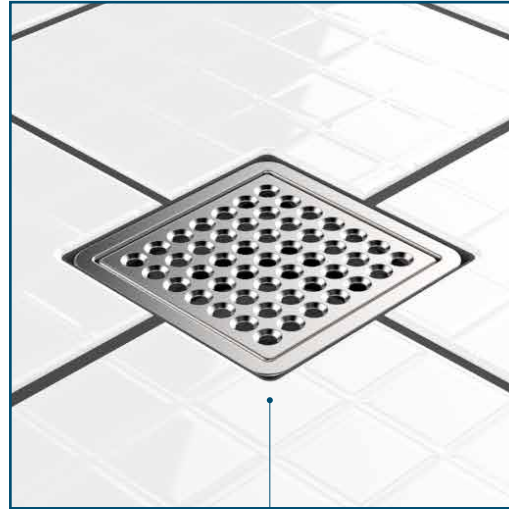

O **porta grelha** deverá estar sempre nivelado com o piso.

Escolha o **porta grelha** conforme a forma da **grelha** que desejar instalar, quadrada ou redonda.

*El porta rejilla deberá estar siempre nivelada con el piso.*

*Escoja el porta rejilla conforme a la forma de la rejilla que desea instalar, cuadrada o redonda.*

**1. porta grelha** - aço inoxidável AISI 304

*porta rejilla - acero inoxidable AISI 304*

**2. anel** - plásticos de engenharia

*anillo - plásticos de ingeniería*

VISTA DAS ETAPAS DE INSTALAÇÃO DO PRODUTO.





Rua João Pessoa, 2566 | Blumenau - SC  
CEP 89036-003 - Fone: +55 47 3331.0800  
CNPJ: 81.604.803/0001-57



[www.blukit.com.br](http://www.blukit.com.br)



[facebook.com.br/canalblukit](https://facebook.com.br/canalblukit)



[youtube.com.br/canalblukit](https://youtube.com.br/canalblukit)